

Quickcrop Treble Bay Compost Bin Assembly Instructions

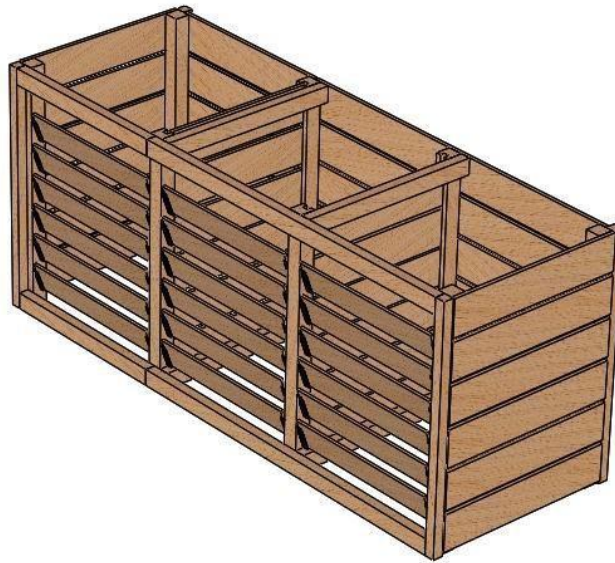

The composter consists of 3 separate bays with removable dividing sections. The dividers and front slats can be removed for filling, emptying and transferring compost between the bays.

The kit is delivered in component parts and assembled using the screws provided.

Boards

6 of 1800x180x20mm rear boards

6 of 900x180x20mm rear boards

12 of 900x180x20mm side boards

14 of 780x180x20mm centre divider boards.

18 of 790x150x13mm front vent boards.

Posts

4 of 1200x750x750mm corner posts.

4 of 1200x750x750mm grooved posts.

Rails

2 of 1800x80x50mm support rails

6 of 900x80x50 support rails.

4 of 1200x50x50 corner finishing rails.

Brackets

36 of moulded plastic mounting brackets.

Fixings

114 of 5.0x60 screws.

80 of 4.0x30 screws.

20 of 5.0x80 screws.

1. Start by assembling the rear section of the composter. Referring to fig.1, place 2 x 1200 corner posts and 2 x 1200 grooved posts 900mm apart with the grooves facing down. Mark the centre line of each corner post (37.5mm).

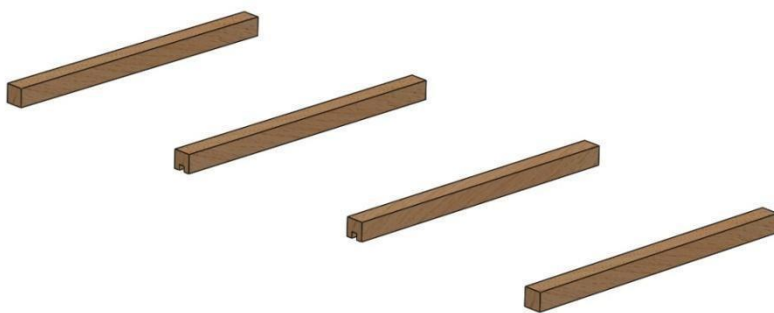

(Fig. 1)

2. Attach corner finishing rails to the corner posts along the length of the centre line (fig.2) with the 5.0x80 screws provided. The finishing rails will overlap the outer edges of the corner posts.

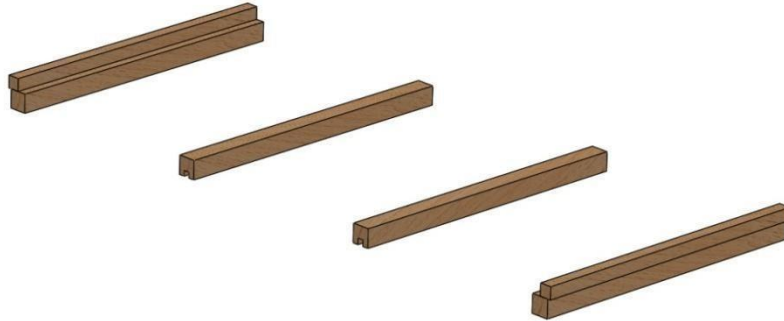

(Fig. 2)

3. Place 6 of the 1800mm rear boards between one of the corner finishing posts (fig 3a). Align the first board with the top of the corner posts and leave a 20mm gap between each subsequent board. Align the edges and centre lines of the boards with the centre lines of the grooved centre posts and fix with the 5.0x60 screws to all posts.

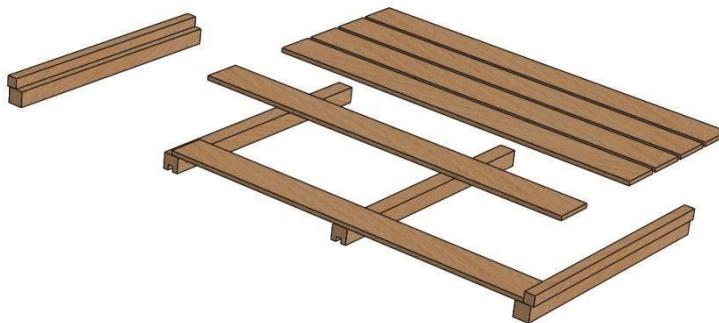

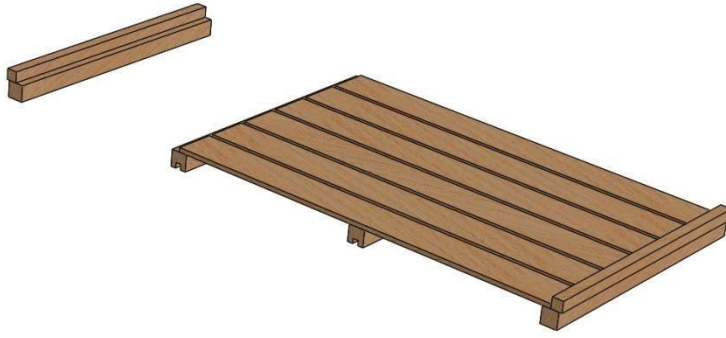

(Fig.3a)

Repeat with the 900mm rear boards, fixing them to the remaining corner post (fig.3b).

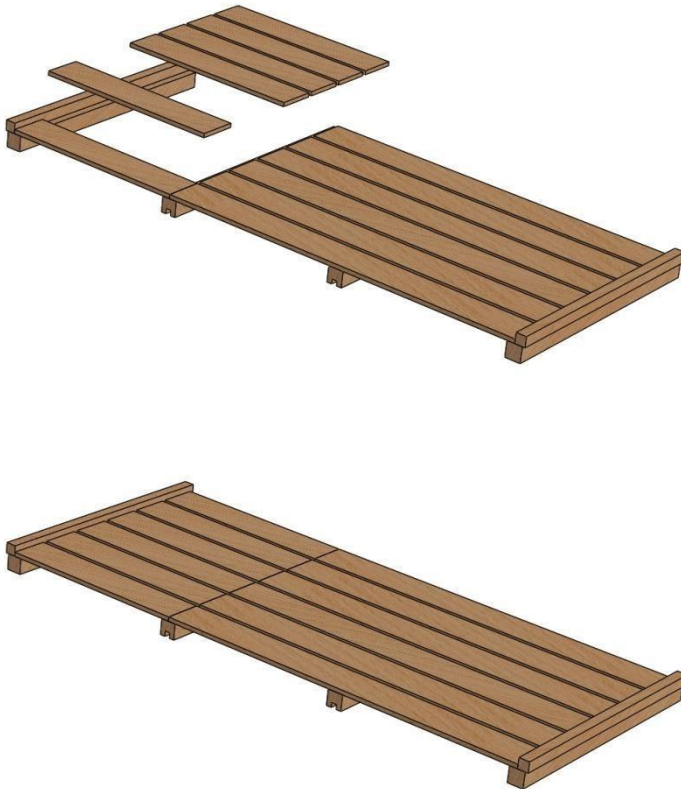

(Fig. 3b)

4. Repeat steps 1- 2 to begin the front section of the composter.

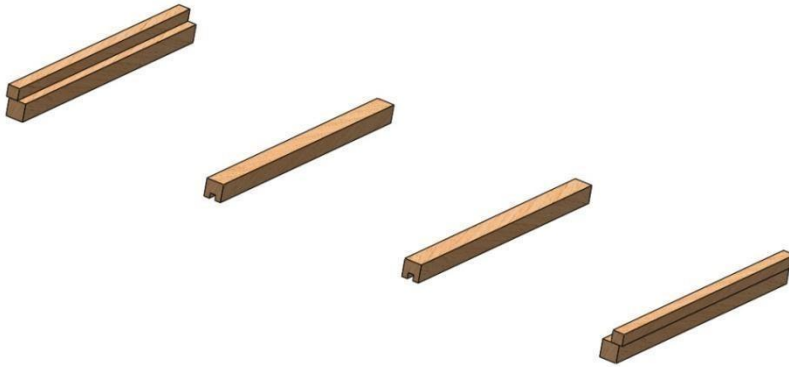

(Fig.4)

5. Referring to fig. 5 attach the 1800x80x50 support rails at either end of the corner posts with the longer 5.0x80 screws provided. Repeat with the shorter 90x80x50 support rails. The longer 80mm edges of the support rails rest facing down against the posts.

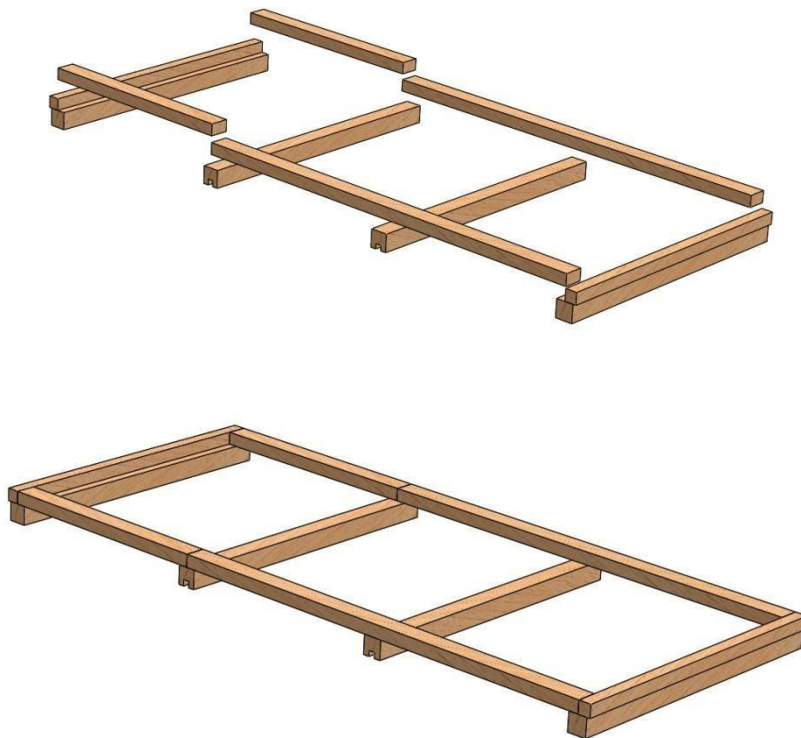

(Fig.5)

6. With the help of an assistant, stand the front and rear sections 825mm apart (fig. 6).



(Fig. 6)

7. Attach the 900x180x20 side boards (fig. 7) using the 5.0x60 screws provided. Start with the top board flush with top of the corner posts and leave a 20mm gap between each subsequent board.

(Fig. 7)

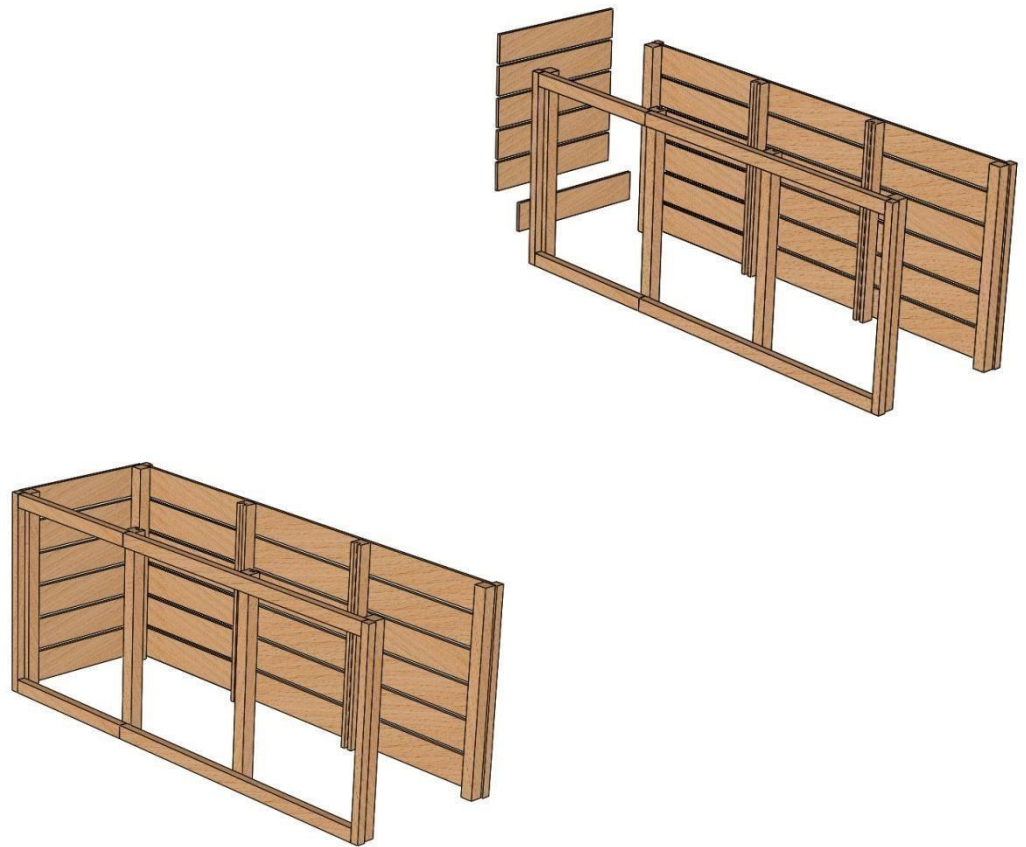

8. Fix the 900x80x50 support rails to the grooved centre posts at the top and the bottom ends (fig. 8) with the 5.0x80 screws. The longer 80mm edges should be in contact with the corner posts.

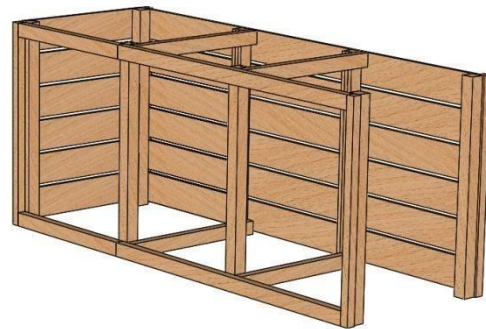
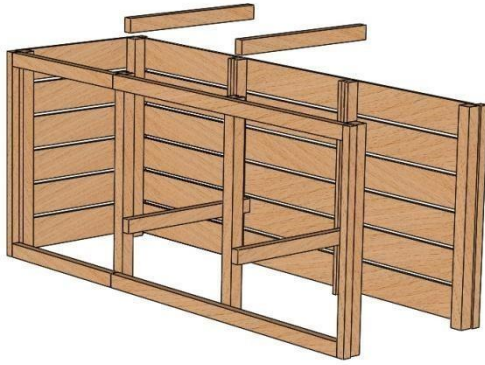

(Fig. 8)

9. Fix the remaining 900 x 180 x 20 side boards to the corner posts (fig. 9) with the 5.0x60 screws. Start with the top board flush with top of the corner posts leaving a 20mm gap between each subsequent board.

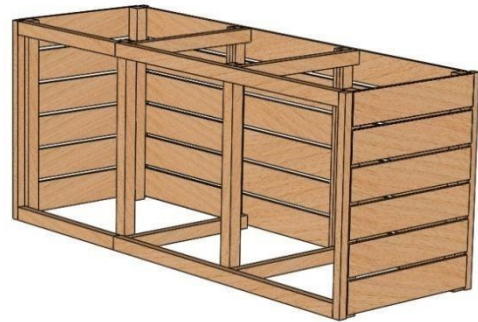
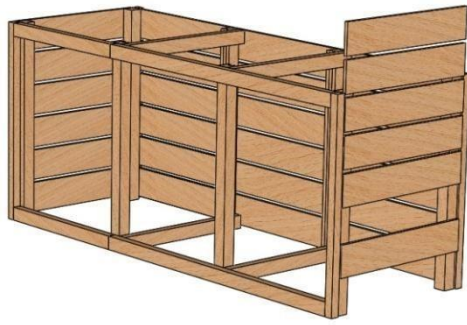

(Fig. 9)

10. Place the bracket mounting template against the corner post, 230mm from the top, and mark the fixing position of the bracket (fig. 10.). Fix the bracket with two 4.0x30 screws provided.



(Fig. 10)

11. Using the template mark the position of the next bracket, 150mm below the top bracket (fig. 11).

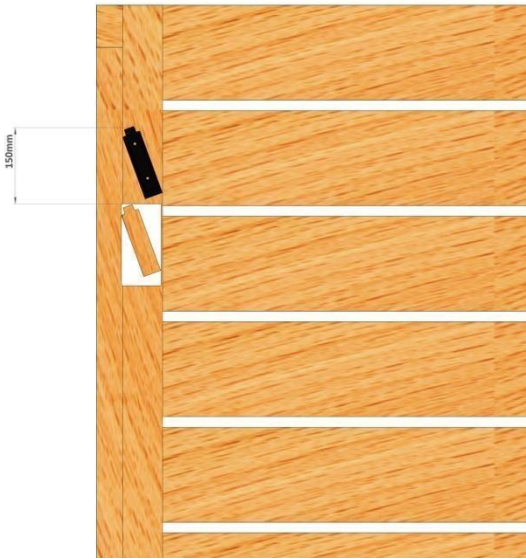

(Fig. 11)

12. Mark and fix the remaining brackets in the same way (fig. 12).



(Fig. 12)

13. Insert the 790mm centre dividing panels into the grooved centre posts (fig. 13). These are not fixed and are intended to be movable to allow transfer of compost between the bays.

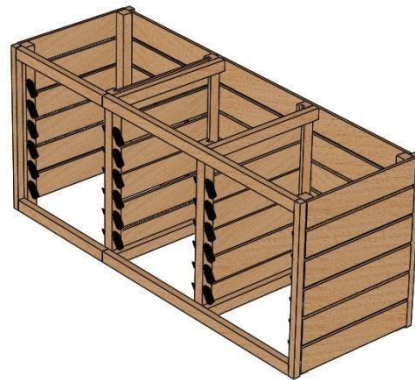

(Fig. 13)

14. The 780mm front vent boards can now be added, slotting into the mounting brackets (fig. 14). The boards can be added or removed quickly for easy access when filling and emptying the bays.

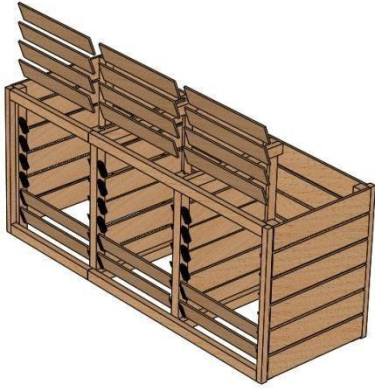

(Fig. 14)

Additional Instructions for Extended Leg Format

The Quickcrop Three Bay Composter is also available in a longer legged format which can be set into the ground at a depth of 300mm. It is assembled in the same way as the short legged format while taking into account the 300mm leg extensions.

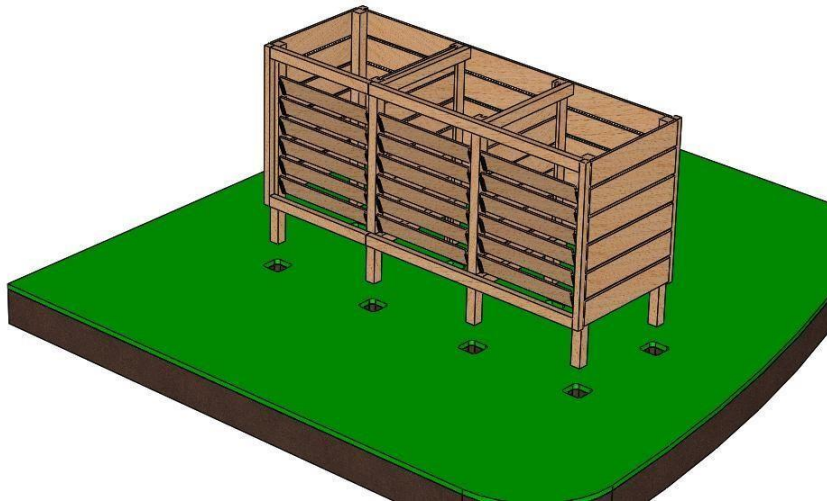

Before installation the area is marked out according to fig.15 to align with the corner posts, 900mm apart

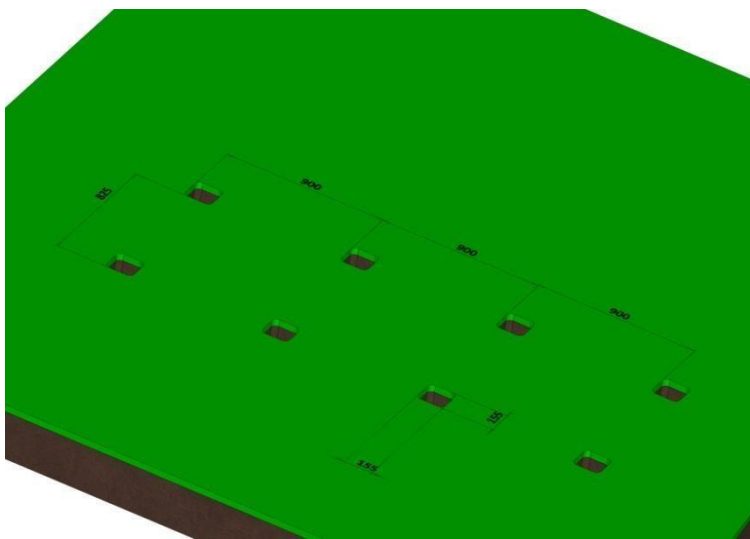

(Fig.15)

The composter posts can be placed into the holes during the build or installed as a unit on completion. The holes should then be compacted and backfilled to ensure stability.

